



ISSN (Print) : 2320 – 3765
ISSN (Online): 2278 – 8875

International Journal of Advanced Research in Electrical, Electronics and Instrumentation Engineering

(An ISO 3297: 2007 Certified Organization)

Vol. 5, Issue 6, June 2016

A Torque Ripple Compensation Technique for a BLDC Motor Drive fed from Solar PV Array using SEPIC converter

P.Vandana¹, Venma Prabhash²

Assistant Professor, Dept. of EEE, Mar Baselios College of Engineering & Technology, Trivandrum, Kerala, India¹

PG Student [PCD], Dept. of EEE, Mar Baselios College of Engineering & Technology, Trivandrum, Kerala, India²

ABSTRACT: Utilization of renewable resources became vital due to the depletion of non-renewable resources and its harmful effects to the environment. Solar energy is an important renewable resource which is abundant in nature and free of running cost though its installation cost is higher. The extracted solar energy is used to drive motors for various applications like water pumping, ventilations etc. Motors used for these applications are dc motors, induction motors or BLDC motors of which BLDC motors are more advantageous. But they use a bulkier dc link capacitor to feed the voltage source inverter. The life time of dc link capacitor is affected by its operating temperature. Also it adds to the cost of BLDC motor drive. The elimination of dc link capacitor reduces the cost and bulkiness of motor drive but it results torque ripple to arise at the output of motor. In this paper, a new method is proposed where the dc link capacitor is replaced by a ceramic capacitor and a switch to minimize the torque ripple. The advantage is that it reduces the torque ripple due to elimination of electrolytic capacitor and the compensation capacitor is only around 3 % of original dc link capacitor.

KEYWORDS: BLDC motors, Solar PV, SEPIC converter, Torque ripple compensation.

I.INTRODUCTION

Demand of energy has increased worldwide due to industrialization and fast growing population, which resulted in great dependence and exploitation of fossil fuels. But the fossil fuels are non- renewable and fast depleting. Moreover, it causes harmful effects on environment like carbon emission, global warming etc. Dependence on renewable energy sources like solar and wind energies are thus receiving wide attention. India was the first country to include a separate ministry under government for renewable sources. Despite of low efficiency of solar PV generating system, the advantages like pollution free generation, no running cost and large abundance in nature made increasing attraction towards its installation[1].The tracked energy can be used for a wide range of applications like water pumping, ventilators etc. Irrigation in remote areas is economical with the use of solar PV water pumping system where transmission of conventionally generated electricity is either costly or not possible. Motors used for driving the water pumps can be DC motors or AC motors. DC motors can be directly connected to solar PV array. Hence the conversion stage can be avoided. But DC motors have the disadvantage of continuous wear and tear of brushes and frequent maintenance. Induction motors require complex control and hence they are also not preferred.

BLDC motors are preferred over DC motors and induction motors due to their advantages like long operating life, higher efficiency, low maintenance and better speed torque characteristics. A bulkier DC link capacitor is connected in between the dc-dc converter and inverter of BLDC motor to get a constant voltage at the input of inverter, thus to make the voltage ripple free. But the life time of a DC link capacitor is affected by its operating temperature. Moreover the cost is about 5-15% of overall cost of BLDC motor drive. As an attempt to reduce the cost of motor, DC link capacitor can be eliminated at the expense of torque ripple. In this paper,a technique to reduce the torque ripple associated with the elimination of the DC link capacitor is proposed. The aim is to reduce the torque ripple of a DC link capacitor free BLDC motor which is fed from a solar PV array using SEPIC converter.

International Journal of Advanced Research in Electrical, Electronics and Instrumentation Engineering

(An ISO 3297: 2007 Certified Organization)

Vol. 5, Issue 6, June 2016

II.SYSTEM MODEL

Figure 1 shows the basic idea of proposed solar PV array- BLDC motor drive. It consists of a solar PV array, dc-dc converter, voltage source inverter, BLDC motor and a pump load. Tracked energy from solar PV array is an unregulated dc voltage which is stepped up or stepped down to a regulated dc voltage by the dc-dc converter. An MPPT algorithm is used to vary the duty ratio of converter to make the system to operate at maximum power point. Switching pulses for inverter is generated according to back emf of the motor using a truth table. Switching pulse for SEPIC converter is generated by MPPT algorithm. A ceramic capacitor and a switch with antiparallel diode are used in place of dc link capacitor between converter and inverter. This is done to reduce the overall cost of BLDC motor drive with dc link capacitor.

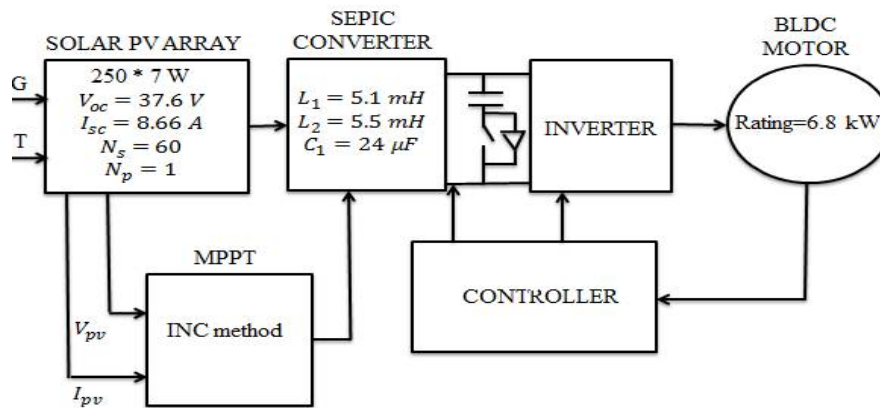

Fig. 1 Configuration of the SPV-SEPIC converter fed BLDC motor with torque ripple compensation

III.MODELING OF BLDC MOTOR

BLDC motors are synchronous motors, which work on the same principle of dc motors. They are electronically commutated motors. Energization of stator windings in a sequence to make rotor running is called commutation. Motor consists of three phase stator windings which are connected in star fashion, rotor made of permanent magnets and a hall sensor. Hall sensors are used to sense the position of rotor so as to know which winding will energise next. A 3 phase, star connected trapezoidal back emf type BLDC motor is used for the mathematical modeling. For simplifying equations and the model, it is assumed that eddy current and hysteresis losses are neglected, armature reaction is not considered and stator windings are symmetrical and concentrated [3]. The matrix equation of phase voltages is:

$$\begin{bmatrix} V_a \\ V_b \\ V_c \end{bmatrix} = \begin{bmatrix} R & 0 & 0 \\ 0 & R & 0 \\ 0 & 0 & R \end{bmatrix} \begin{bmatrix} i_a \\ i_b \\ i_c \end{bmatrix} + \begin{bmatrix} L - M & 0 & 0 \\ 0 & L - M & 0 \\ 0 & 0 & L - M \end{bmatrix} p \begin{bmatrix} i_a \\ i_b \\ i_c \end{bmatrix} + \begin{bmatrix} e_a \\ e_b \\ e_c \end{bmatrix} \quad (1)$$

where R is the resistance of each phase (Ω), L is the self-inductance of each phase (H), M is the mutual inductance between any two phases, V_a, V_b, V_c are the stator phase voltages (V), i_a, i_b, i_c are the stator phase currents in (A), e_a, e_b, e_c are the back emf signals (V) of BLDC motor and p is the differential operator.

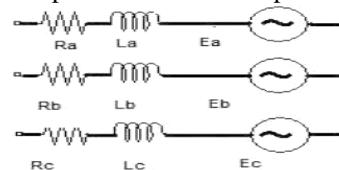

Fig. 2 BLDC motor equivalent model

$$V_a = Ri_a + L \frac{d}{dt}(i_a) + e_a \quad (2)$$

$$V_b = Ri_b + L \frac{d}{dt}(i_b) + e_b \quad (3)$$

$$V_c = Ri_c + L \frac{d}{dt}(i_c) + e_c \quad (4)$$



International Journal of Advanced Research in Electrical, Electronics and Instrumentation Engineering

(An ISO 3297: 2007 Certified Organization)

Vol. 5, Issue 6, June 2016

In a three phase BLDC motor back emf is related to as a function of rotor position. Rotor position function is a unit function generator which has a maximum value of +1 or -1 which have a phase difference of 120° between each phase [4].

$$e_a = k_w f(\theta_e) \omega \quad (5)$$

$$e_b = k_w f(\theta_e - 2\pi/3) \omega \quad (6)$$

$$e_c = k_w f(\theta_e + 2\pi/3) \omega \quad (7)$$

Where k_w is back EMF constant per phase [V/rad.s⁻¹], θ_e is electrical rotor angle [° el.], ω is rotor speed [rad.s⁻¹].

The equation of electromagnetic torque is:

$$T_e = \frac{1}{\omega} (e_a i_a + e_b i_b + e_c i_c) \quad (8)$$

The mechanical torque is given by

$$T_m = J \frac{d\omega}{dt} + B\omega + T_L \quad (9)$$

Where J is the moment of inertia of drive [kgm²], B is the damping constant [Nm.s.rad⁻¹], T_L is the load torque [Nm]. A 6.14 kW BLDC motor is used to drive a pump load of 6 kW. The parameters of a 6.14 kW BLDC motor is shown in Table I.

TABLE I
MOTOR PARAMETERS

Motor value	Parameters
Stator inductance per phase	2.55 m H
Stator resistance per phase	0.43Ω
Moment of inertia, J	0.0689 kgm ²
Friction coefficient, B	0.05 Nm.s.rad ⁻¹
Rated speed	2300 rpm
Rated power	6.14 Kw
Back emf constant	0.51 V/rad.s ⁻¹

IV. MODELING OF PV MODULE

A PV cell is a p-n junction diode fabricated in a thin wafer of semiconductor which works on the principle of photo electric effect, electricity is generated when light falls on it. Current through output of a PV module is

$$I = N_p I_{ph} - N_p I_o \left(\exp \left[\frac{q(V/N_s + IR_s/N_p)}{AKT} \right] - 1 \right) - \frac{V + IR_s}{R_p} \quad (10)$$

where V is the voltage of the PV module, I_{ph} is the photo-current, I_o is the reverse saturation current, N_p is the number of cells connected in parallel, N_s is the number of cells connected in series, q is the charge of an electron (1.6×10^{-19} C), k is Boltzmann's constant (1.38×10^{-23} J/K), A is p - n junction ideality factor, ($1 < a < 2$, $a = 1$ being the ideal value), and T is the PV module temperature. Output of PV module varies with photo current which depends on solar irradiance and PV module temperature [5].

$$I_{ph} = G [I_{sc} + k_1 (T - T_{ref})] \quad (11)$$

Where I_{sc} is the short circuit current of the PV cell, k_1 is the temperature coefficient T is the current atmospheric temperature and T_{ref} is the temperature at nominal condition (25°C and 1000W/m²), G is the current irradiance level. Maximum power capacity of array is 7 kW to drive a 6 kW pump. A 250 W PV module is simulated and the modules are connected in series and parallel to attain a 7 kW PV array. The electrical parameters of a 250 W PV module are shown in Table II.

TABLE III
PV MODULE PARAMETERS

Electrical parameters	Value
Maximum Power (P_{max})	250 W
Open Circuit Voltage (V_{oc})	37.6 V
Short Circuit Current (I_{sc})	8.66 A
Number of Series Cells (N_s)	60

Figure 3 (a) and (b) shows the P-V curve and I-V curve for different irradiation levels of a 7 kW PV array respectively. In figure 3(a) the open circuit voltage decreases slightly when irradiation is reduced from 1000 W/m² to 600 W/m² whereas in figure 3(b), the short circuit current decreases largely when irradiation is reduced from 1000 W/m² to 500 W/m².

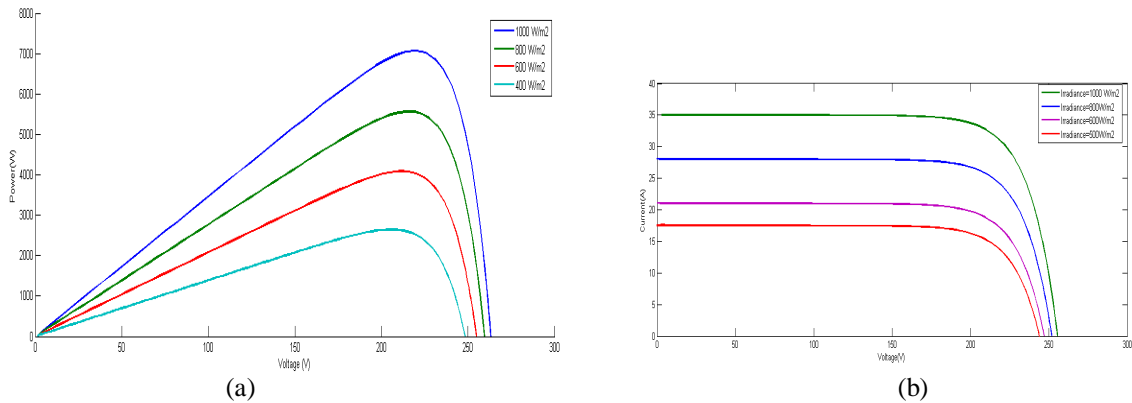

Fig. 3 PV and IV characteristics for different irradiation levels

To utilize the trapped power from the available power, we make use of maximum power point techniques. The implementation of technique can be done on the dc-dc converter to change its duty ratio, so as to obtain the required voltage at the output of converters. Of the different MPPT techniques, Incremental conductance method is used here. The method senses voltage and current of the PV panel. At maximum power point, the slope of PV curve is zero ($dP/dV=0$). Slope of PV curve increases on positive of MPP and decreases on negative of MPP. The slope is given by

$$\frac{dP}{dV} = \frac{d(V \cdot I)}{dV} = I + V \left(\frac{dI}{dV} \right) = 0 \quad (12)$$

At MPP,

$$\frac{\Delta I}{\Delta V} = -\frac{I}{V} \quad (13)$$

On the left of MPP,

$$\frac{\Delta I}{\Delta V} > -\frac{I}{V} \quad (14)$$

On the right of MPP,

$$\frac{\Delta I}{\Delta V} < -\frac{I}{V} \quad (15)$$

V. SEPIC CONVERTER

The PV array is followed by a SEPIC converter. A SEPIC converter is a dc-dc converter which gives a positive regulated voltage at the output. By changing the duty ratio of converter, required output voltage is obtained. When switch T is closed, diode is in reverse biased condition. Inductor L_1 charges, current in L_1 increases and the current in L_2 increases in negative direction. Capacitor C_1 discharges the energy through switch to increase the magnitude of current in L_2 . When switch T is open, diode is in forward biased condition. Power is delivered to load from both L_1 and L_2 . Capacitor C_1 is charged from L_1 during the off cycle [6].

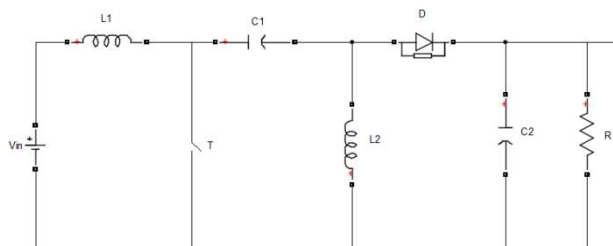

Fig. 4 Circuit diagram of SEPIC converter



International Journal of Advanced Research in Electrical, Electronics and Instrumentation Engineering

(An ISO 3297: 2007 Certified Organization)

Vol. 5, Issue 6, June 2016

The output voltage is given by

$$\frac{V_o}{V_{in}} = \frac{D}{1-D} \quad (16)$$

The rated DC voltage of the BLDC motor is $V_{dc} = 310 V$, the output of SEPIC converter and PV voltage at MPP is $V_{pv} = 286 V$, the input to SEPIC converter. Hence,

$$\frac{V_{dc}}{V_{pv}} = \frac{D}{1-D} \quad (17)$$

$$D = \frac{V_{dc}}{V_{dc}+V_{pv}} = \frac{310}{310+286} = 0.52 \quad (18)$$

Current flowing through L_1 is the output current of PV array at MPP. $I_{L1} = I_{pv} = 24.02 A$. Allowing 6% current ripples, with a switching frequency of 20 kHz, input inductor

$$L_1 = \frac{DV_{in}}{f\Delta I_{L1}} = \frac{0.52*286}{20000*0.06*24.02} = 5.1 \text{ mH} \quad (19)$$

Current flowing through output inductor L_2 is

$$I_{L2} = \frac{P_{pv}}{V_{dc}} = \frac{7000}{310} = 22.58 \text{ A} \quad (20)$$

$$L_2 = \frac{DV_{in}}{f\Delta I_{L2}} = \frac{0.52*286}{20000*0.06*22.58} = 5.5 \text{ mH} \quad (21)$$

The voltage across capacitor C_1 is

$$V_{C1} = \frac{V_{pv}}{1-D} = \frac{286}{1-0.52} = 595.8 \text{ V} \quad (22)$$

Allowing a 4 % voltage ripple,

$$C_1 = \frac{I_{pv}(1-D)}{f\Delta V_{C1}} = \frac{24.02(1-0.52)}{20000*0.04*595.8} = 24 \mu\text{F} \quad (23)$$

$$C_2 = \frac{\Delta I_{L2}}{8f\Delta V_{C2}} = 470 \mu\text{F} \quad (24)$$

Where D is the duty ratio of dc – dc converter, f is the switching frequency, ΔV_{C1} and ΔV_{C2} are the voltage ripples of two capacitors, ΔI_{L1} and ΔI_{L2} are the current ripples in L_1 and L_2 respectively.

VI. TORQUE RIPPLE COMPENSATION

The idea to eliminate the bulkier dc link capacitor causes the introduction of torque ripples at the output of motor. Hence a new method proposed is a low value inexpensive capacitor (ceramic capacitor) and a switch connected between the converter and the inverter. The ceramic capacitor used to reduce the torque ripple has a value of $25 \mu\text{F}$ which replaces a $470 \mu\text{F}$ dc link capacitor. A switch with antiparallel diode is used to provide the required current to run the motor. The motor drive is fed with a voltage between 0 to 325 V without a dc link capacitor. The build-up of phase current is possible when rectified mains voltage is greater than back emf. With the compensation technique, capacitor is charged when input voltage is less than back emf. Energy stored in capacitor is discharged when $V_m < E$, so that current in motor is maintained at current reference [7]. Discharge of capacitor can be controlled by gating pulse applied to the switch. Controller is developed in such a way that gating pulse is generated based on value of back emf and rectified mains voltage.

$$T = \frac{1}{2\pi f} \sin^{-1} \frac{E}{V_m} \quad (25)$$

where T is the time taken for $V_{in}(t)$ to reach E from 0 V.

V_m is peak value of voltage (V).

f is the frequency of input supply voltage (Hz).

At $E=100 \text{ V}, V_m=310 \text{ V}$,

International Journal of Advanced Research in Electrical, Electronics and Instrumentation Engineering

(An ISO 3297: 2007 Certified Organization)

Vol. 5, Issue 6, June 2016

$$T = \frac{1}{2 \cdot \pi \cdot 50} \sin^{-1} \frac{100}{310} = 1.23 \text{ ms} \quad (26)$$

The value of C_{DC} is selected such that it is capable to provide the required reference current when $V_m < E$ to maintain current at reference. The minimum value of capacitance that is required to provide current at reference is

$$C_{DC} = \frac{2T I_{avg}}{V_m - E} \quad (27)$$

With $I_{avg} = 2 \text{ A}$, C_{DC} is calculated as

$$C_{DC} = \frac{2 \cdot 1.23 \cdot 10^{-3} \cdot 2}{310 - 100} = 23 \mu\text{F} \quad (28)$$

A ceramic capacitor of $25 \mu\text{F}$ with a switch thus replaces a $470 \mu\text{F}$ capacitor.

VII. RESULT AND DISCUSSION

The modelling of torque ripple compensation technique of BLDC motor with compensation capacitor is carried out in MATLAB™/SIMULINK™. The simulation is carried out for an irradiance of 1000 W/m^2 to compare the torque ripple at the output of BLDC motor with and without a compensation capacitor. Fig. 5(a) shows the electromagnetic torque of a 6.8 kW BLDC motor with compensation capacitor. The result is compared with another BLDC motor of same rating without a compensation capacitor whose electromagnetic torque is as shown in Fig5(b). At 1000 W/m^2 , motor has a rated current of 25A at rated torque of 25 N-m.

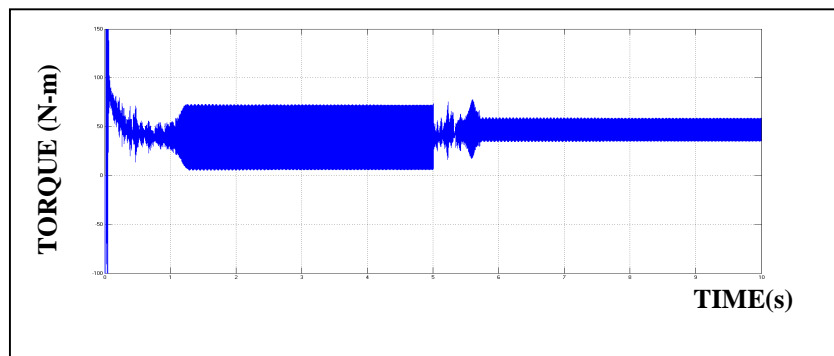

(a)

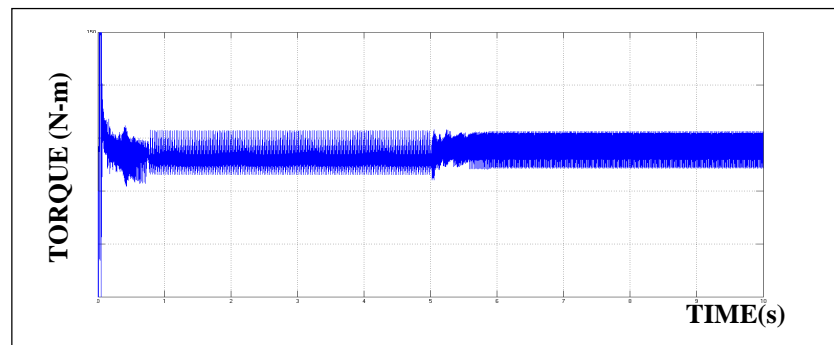

(b)

Fig. 5 Electromagnetic torque output of a BLDC motor for a step load torque of 15 to 25 N-m for $G=1000 \text{ W/m}^2$ (a) with compensation capacitor (b) without compensation capacitor

Motor with a low value capacitor runs satisfactorily at $G=1000 \text{ W/m}^2$ with a rated dc voltage of 310 V at the output of SEPIC converter. This voltage appears across the compensation capacitor and switch. The low value capacitor along with switch is able to drive the motor at rated condition. Motor has a peak current of 30 A and a speed of 2200 rpm at this irradiance level. Figure 6 shows the converter output voltage or the voltage across the compensation capacitor and switch. The rated voltage is applied to the motor using the compensation technique. It is able to drive the motor at rated

International Journal of Advanced Research in Electrical, Electronics and Instrumentation Engineering

(An ISO 3297: 2007 Certified Organization)

Vol. 5, Issue 6, June 2016

dc link voltage with a reduced torque ripple as compared with a motor with no compensation capacitor. As the irradiance decreases, motor torque, phase current, back emf, speed and phase voltage decreases.

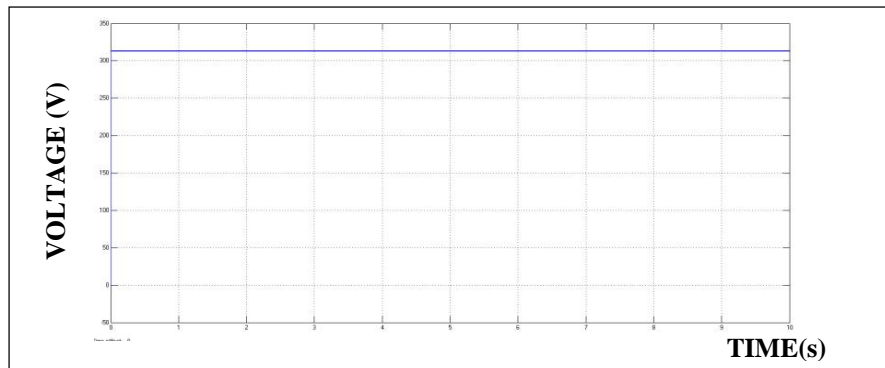
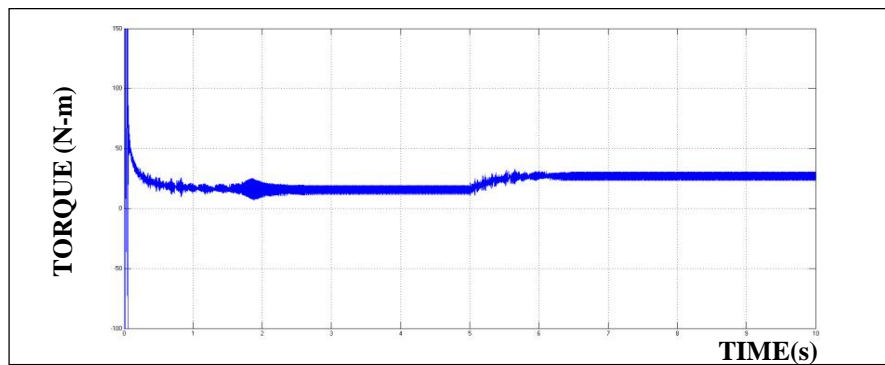
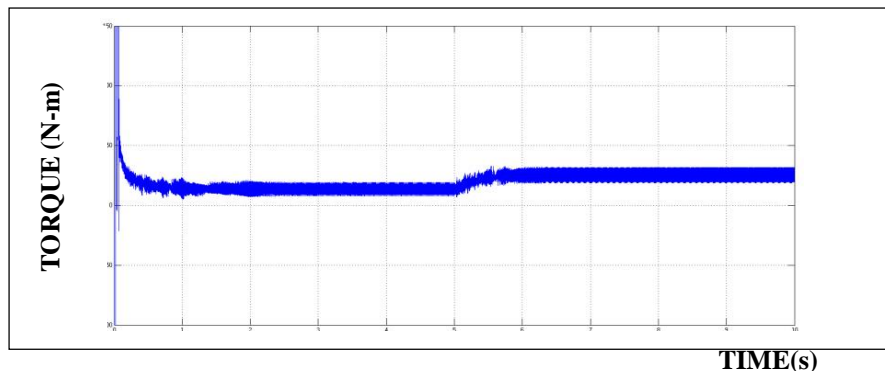

Fig. 6 Converter output voltage with compensation capacitor for $G=1000 \text{ W/m}^2$

Irradiance is changed from 1000 W/m^2 to 600 W/m^2 to demonstrate the performance of motor. When the solar irradiance is changed from 1000 W/m^2 to 600 W/m^2 , as amount of tracked energy is less, the converter output voltage is less due to which the electromagnetic torque and stator current decreases. Torque generated with 600 W/m^2 is less than that generated with 1000 W/m^2 . There is a comparable reduction in ripple in the electromagnetic torque with compensation capacitor shown in figure 7(a) when comparing with the torque generated in a BLDC motor of same rating without compensation capacitor as shown in figure 7(b).



(a)



(b)

Fig. 7 Electromagnetic torque output of a BLDC motor for a step load torque of 15 to 25 N-m for $G=600 \text{ W/m}^2$ (a) with compensation capacitor (b) without compensation capacitor.



International Journal of Advanced Research in Electrical, Electronics and Instrumentation Engineering

(An ISO 3297: 2007 Certified Organization)

Vol. 5, Issue 6, June 2016

As the solar irradiance level decreases, the dc link voltage, speed, stator current and back emf of motor reduces. At $600\text{W}/\text{m}^2$, the stator current reduces to a peak value of 17 A. The speed of motor reduces to 1900 rpm and the dc voltage at the output of converter is 230 V. Figure 8 shows the output voltage of SEPIC converter with compensation capacitor at $G=600\text{W}/\text{m}^2$.

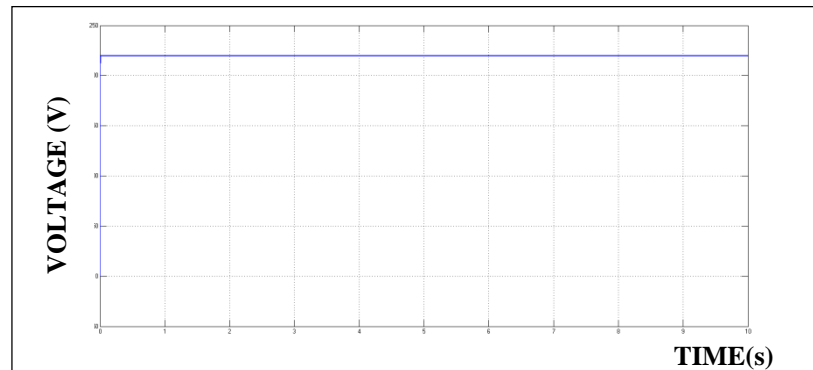

Fig. 8 Converter output voltage with compensation capacitor for $G=600\text{ W}/\text{m}^2$

VI. CONCLUSION AND FUTURE SCOPE

A compensation technique for the torque ripple reduction in a BLDC motor operated without dc link capacitor is proposed. The new technique is analysed for a BLDC motor which is fed from a solar PV array using SEPIC converter. To maintain a constant dc link voltage for a particular irradiance level, an MPPT technique is used. Performance of motor with compensation technique was analysed for irradiance level of $1000\text{ W}/\text{m}^2$ and $600\text{ W}/\text{m}^2$. Torque ripple was reduced in both cases by using this compensation technique. With the use of the compensation capacitor of low value, the motor is able to operate in the rated speed and torque. The method can be used for water pumping applications. Also, the method can be analysed with buck-boost converter, Cuk converter or zeta converter.

REFERENCES

- [1] Rajan Kumar and Bhim Singh, "Buck –Boost Converter Fed BLDC Motor Drive for Solar PV array Based Water Pumping," IEEE International Conference on Power Electronics, Drives and Energy Systems , pp. 1-6, Feb 2014.
- [2] Rajan Kumar and Bhim Singh, "Solar PV Array Fed Cuk Converter-VSI Controlled BLDC Motor Drive for Water Pumping," 6th IEEE Power India International Conference, pp. 1-7, Feb 2014.
- [3] Swathikumari, A. Y. Lakshminarayana and S. Tarakalyani, "Modeling and Simulation of BLDC Motor for Aiding and Opposing Loads," IOSR Journal of Electrical and Electronics Engineering, vol. 7, no. 4, pp. 59-67, Oct 2013.
- [4] S. Rambabu, "Modeling and Control of a Brushless DC Motor," M. Eng. thesis, National Institute of Technology, Rourkela, India, May. 2007.
- [5] Aminul Islam and Adel Merabet, "Modeling Solar Photovoltaic cell and Simulated Performance Analysis of a 250 W PV module," IEEE Electrical Power and Energy Conference, pp. 1-6, 2013.
- [6] Soumya Ranjan Behera and Thabir Kumar Meher, "Design of Single Ended Primary Inductor DC-DC Converter," B. Eng. thesis, National Institute of Technology, Rourkela, India, May. 2013.
- [7] H. K. Samitha Ransara and U. K. Madawala, "A Torque ripple compensation technique for a low cost Brushless dc motor drive," IEEE Trans. Industrial Electron., vol. 62, no. 10, pp. 6171–4182, Oct 2015.