



A Novel Simulation and Analysis of SPWM Inverter

A. Kumar¹ Vanita Batra²

Assistant Professor, Dept. of EE, Vaish College of Engineering, Rohtak, Haryana, India¹

Assistant Professor, Dept. of ECE, Vaish College of Engineering, Rohtak, Haryana, India²

ABSTRACT: Pulse Width Modulated switching power converters and variable speed drives are increasingly applied in industrial application for converting and delivering their required energy to the motor or loads that require superior performance and control. In power electronics PWM is broadly used to digitize the power for superior controlling. Exceptionally neither the voltage nor the current waveforms are as per expectation. Usually they are distorted and produces harmonic in the power signals. These harmonic contaminations produce additional power impairment, and high frequency clamors. In this paper a Sinusoidal pulse width modulated single-phase full bridge inverter and its operating principle is analyzed in detail. The Sinusoidal pulse width modulation or Carrier based Pulse Width Modulation Technique and its results are also verified with the help of Mat-lab simulation model.

KEYWORDS: Modulation, PWM, SPWM technique, Unipolar SPWM, Simulation etc.

I. INTRODUCTION

The DC to AC converting device also known as inverter basically converts direct current into alternating current. Classification of Inverters is divided into two types, voltage source and current source inverters. A voltage–source inverter (VSI) in which the dc source has small or negligible impedance and a current –source inverter (CSI) in which dc source of high impedance [1]. The inverters are intended to use DC power from a conventional or non conventional energy source and change it to AC. The most common example is the household inverters that uses DC energy supply from 12V or 24V lead acid battery and changes it to 240V, 50Hz or 120V, 60Hz AC. Recently with positive development in the semiconductor power electronic devices now inverters are delivering an important role in controlling various renewable energy applications such as connection of Wind Energy System or Photovoltaic System [2]. Inverters usually operate on an advance and useful technique known as Pulse Width Modulation (PWM) technique. This technique employs controlled gate pulse operation for controlling the output desired voltage irrespective of output load. Depending on the output need there is several different circuit configuration designed and employed in PWM inverters and have become popular [3]. The most widely employed PWM scheme for voltage source inverters is sinusoidal PWM. In the most unpretentious implementation, the desired output voltage generation is achieved by weighing the desired (reference) voltage waveform signal also known as modulating signal with a high-frequency triangular or carrier wave. The result of this operation is a chopped square waveform that contains a transcription of its low frequency components in higher frequency components close to the carrier frequency. It is very important to note that over the period of triangle wave, the voltage applied to the load is proportional to the amplitude of the signal during this period. However, a higher carrier frequency does result in a larger number of switching per cycle and hence in an increased power loss. Typically switching frequencies in the 2-15 kHz range are considered adequate for power systems applications [4]. The objective of this paper is to analysis sinusoidal pulse width modulation technique for a 250W inverter and the results are verified through use of mat-lab simulation.

II. SINUSOIDAL PULSE WIDTH MODULATION (SPWM)

Unipolar Sinusoidal pulse width modulation: As in the other pulse width modulation technique maintaining the same width of all pulses [5][6], disrespected to this the width of each pulse is variegated in the sinusoidal pulse width modulation technique. The variation in the width of pulse is in the proportion to the amplitude of the sine wave slop evaluated at the centre of the each pulse. It is very desired that the output ac voltage must pursue a given sinusoidal

waveform. In PWM techniques except SPWM the output is not a sin wave. To achieve and fulfil desired requirement the SPWM technique presents the solution. For producing derided output SPWM defines the switching states of VSI by comparing modulating sin wave signal amplitude with a triangular carrier waveform voltage. The gating signals are generated by comparing a sinusoidal reference signal as shown in fig. 3 with a triangular carrier wave of frequency as shown in fig. 4. The frequency of reference signal is f_r the inverter output frequency. The carrier frequency determines the number of pulses per cycle in modulation [7] [8]. As in the fig. 5 until the carrier voltage is higher than the reference signal ($V_c > V_r$) the switching pulse is high similarly, when the carrier voltage is lesser than the reference signal ($V_c < V_r$) switching pulse is low [9][10]. Pulses produced by comparing of signals than amplified to a suitable value and then used for switching the semiconductors in inverter in present case to the Mosfets. Fig. 6 shows a simplified block representation for the generation of gating pulses of mosfets. In the present work a full bridge fully controlled technique is implemented for the inverter. Mosfet 1 and 2 works together and produces positive voltage as output and Mosfet 3 and 4 produces negative voltage in output. Through a suitable LC filter, the output of full wave bridge inverter with SPWM signal will generate a wave approximately equal to a sine wave. Than this sin wave voltage is feuded to the 500W transformer which further increases the voltage to the required level of about 240V, 50Hz. Fig. 7 and fig. 8 shows the simulation arrangement for the said technique[11][12].

Advantages of SPWM

- Low power consumption.
- High energy efficient up to 90%.
- High power handling capability.
- No temperature variation-and ageing-caused drifting or degradation in linearity.
- Easy to implement and control.
- Compatible with today's digital microprocessors

Disadvantages of SPWM

- Attenuation of the wanted fundamental component of the waveform.
- Drastically increased switching frequencies that leads to greater stresses on associated switching devices and therefore de-rating of those devices.
- Generation of high-frequency harmonic components.

III. RESULT AND DISCUSSION

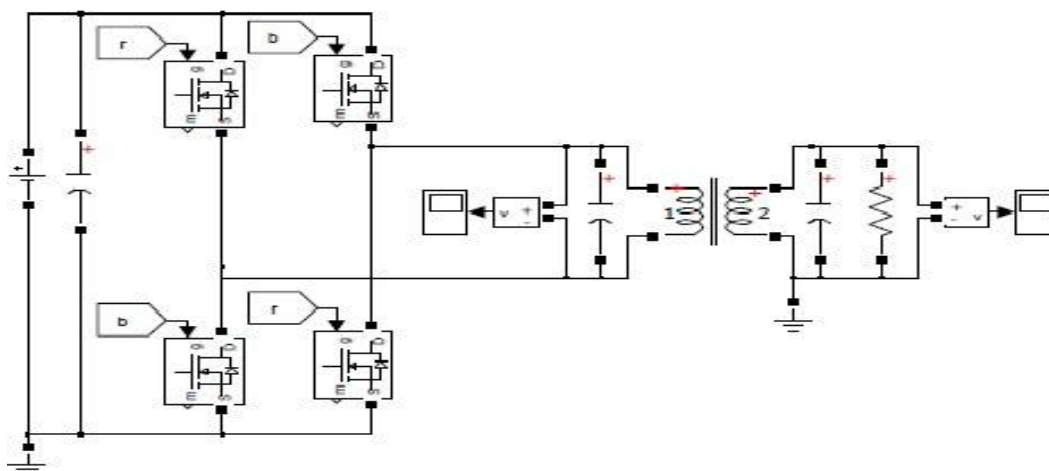

Fig. 1 Simulation model for the DC to AC full bridge fully controlled bridge inverter for 500W inverter. In simulation model a fixed DC voltage is used to feed the inverter. In this 4 power Mosfet are used for switching of inverter operation. The output of mosfet is then filtered and stepped up to the desired value of AC voltage using a transformer.

International Journal of Advanced Research in Electrical, Electronics and Instrumentation Engineering

(An ISO 3297: 2007 Certified Organization)

Vol. 5, Issue 11, November 2016

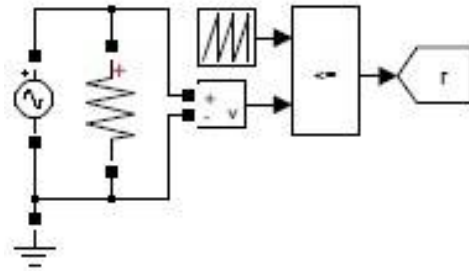

Fig. 2 This simulation model shows the generation of SPWM. The required SPWM pulses for triggering of Mosfets are generated by comparing sin wave of suitable amplitude and having 50Hz frequency with a triangular wave of 2 kHz frequency.

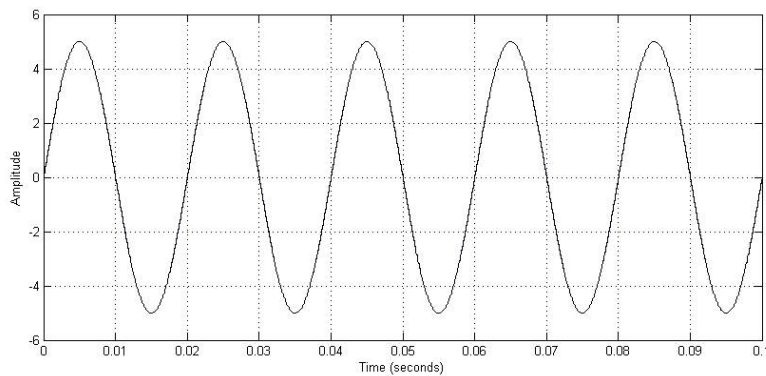

Fig. 3 shows the reference sin wave inverter frequency of 50Hz to be compared with triangular signal.

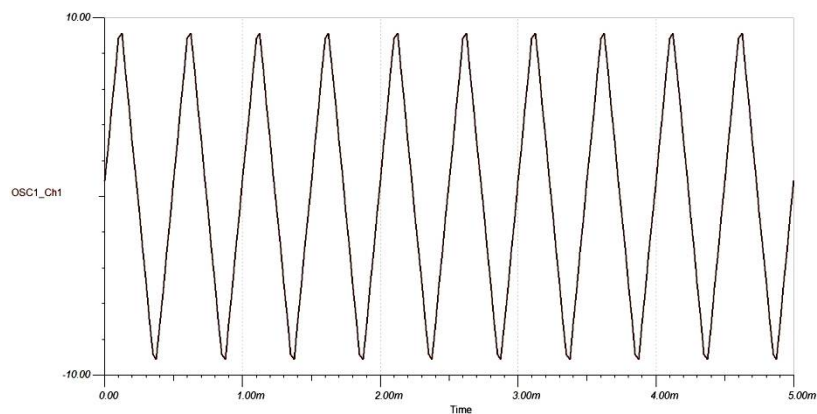

Fig. 4 shows the 2 kHz Triangular carrier wave for the comparing and modulation of sin wave.

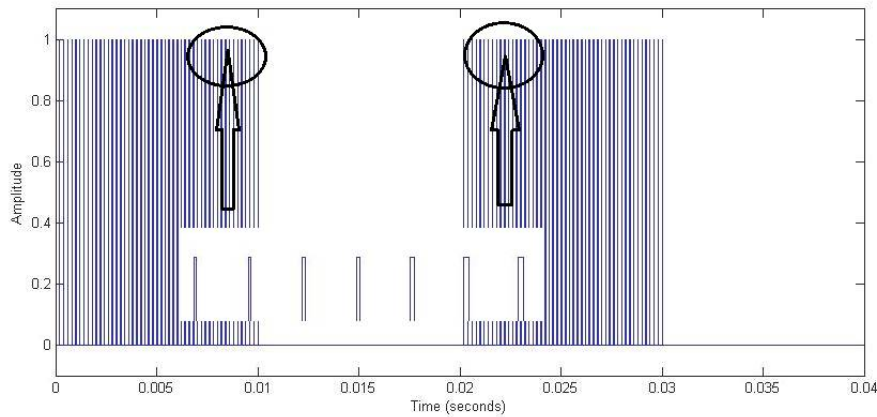

Fig. 5 Shows the resultant SPWM output of the switching pulse generator model after the compression of sin and triangular wave. From the fig it is clear that the resultant pulses are having unequal width which is the requirement of presented technique.

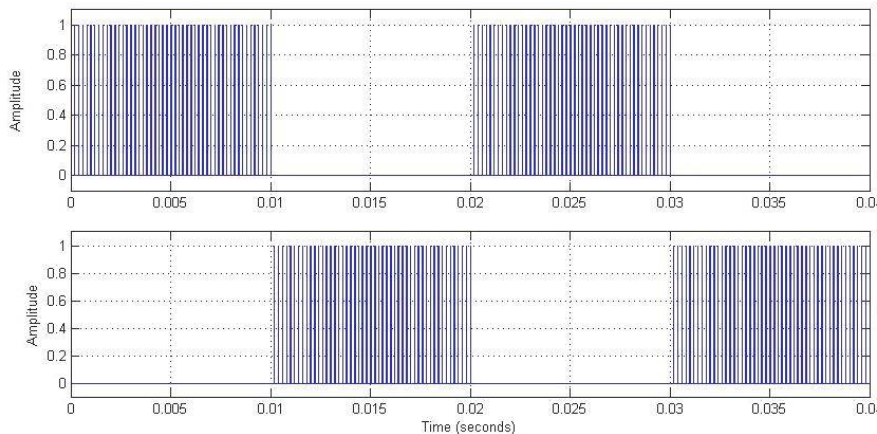

Fig. 6 Shows the final SPWM pulse for the triggering of positive and negative pairs of Mosfets respectively. The upper pulses provides triggering pulses for positive pairs of the Mosfets named as **r** and lower pulses provides triggering pulses for negative pairs of the Mosfets named as **b**.

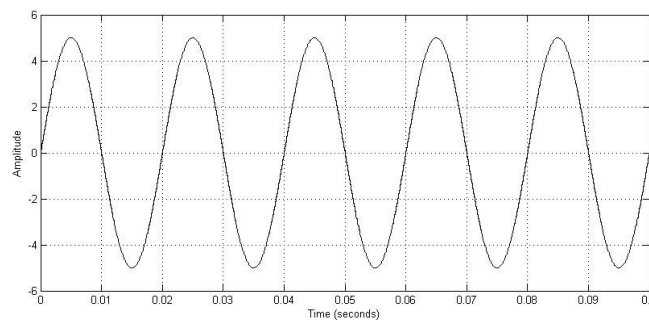

Fig. 7 This fig. shows the sinusoidal voltage filtered with the help of LC filter and feuded to the step up transformer of 500VA.



International Journal of Advanced Research in Electrical, Electronics and Instrumentation Engineering

(An ISO 3297: 2007 Certified Organization)

Vol. 5, Issue 11, November 2016

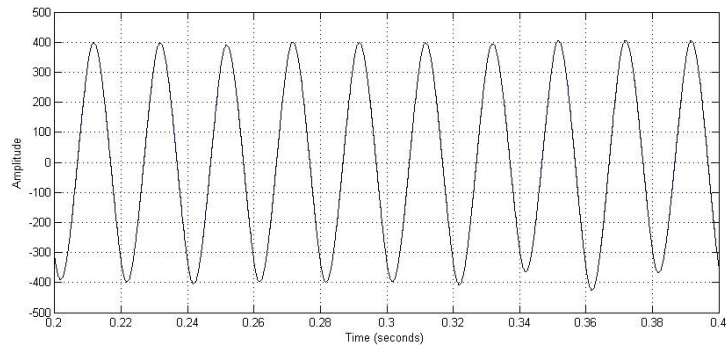

Fig. 8 Above fig. shows the Sinusoidal output voltage from the transformer after stepping up of the voltage to the required level.

IV.CONCLUSION

PWM control within inverters is the most efficient method of commending output voltage. Pulse Width Modulation technique based controlled supplies and variable speed drives are increasingly applied in industrial applications that require superior performance. In this paper a single phase SPWM based 500VA unipolar voltage switching inverter is designed and simulated for fixed load. It gives a different result of currents and voltages for different loads. SVPWM technique improves the quality of the voltage and current of the system, hence improving the quality of the system. In order to accomplish a much better performance, several improvements are being made and the work is in progress.

REFERENCES

- [1] D. Anand & Jeevananthan .S "Modeling and Analysis of Conducted EMI Emissions of a Single-Phase PWM Inverters" Asian Power Electronics Journal, Vol. 4, No.3 December 2010.
- [2] M.S. Khanniche,, "A novel switching strategy of a single phase micro controlled UPS system ", Electrotechnical Conference, 1991. Proceedings. 6th Mediterranean Publication Year: 1991, vol.2 pp. 1360 – 1362.
- [3] J. S. Lai and F. Z. Feng, "Multilevel converters-a new breed of power converters," IEEE transaction on industrial applications, Vol. IA-32, 1996, pp. 509-517.
- [4] K. P. Hitendra, N. A. Kapildev, "Simulation Of Three Level Inverter Using Sinusoidal Pulse Width Modulation Technique By MATLAB" International Journal of Engineering Science and Technology Vol. 2(11), 2010, pp.6500-6506.
- [5] M. Ali.I & Al-Ammar. Essam "Analysis of a PWM Voltage Source Inverter with PI Controller under Non-ideal conditions" International Power Engineering Conference IPEC,2010.
- [6] I. F. Crowley & H. F. Leung, "PWM Techniques: A Pure Sine Wave Inverter" Worcester Polytechnic Institute Major Qualifying Project, 2010.
- [7] K. J. Choi & H. Hong, "Output LC Filter Design of Voltage Source Inverter Considering the Performance of Controller" IEEE Conference Publications, 2000.
- [8] E. Cengelci, S. U. Sulistijo, B. O. Woom, P. Enjeti, R. Teodorescu, and F. Blaabjerge, "A new medium voltage PWM inverter topology for adjustable speed drives," in Conf. Rec. IEEE-IAS Annu. Meeting, St. Louis, MO, Oct. 1998, pp. 1416–1423.
- [9] S. Rao and A. Vujji, " SVPWM Based Speed Control of Induction Motor Drive with Using V/F Control Based 3-Level Inverter" VSRD-IJEECE, Vol. 2 (7), 2012, 421-437.
- [10] F. Ainipatakar, M. S. and Zulkiflieibrahim, " Comparison Performance Of Induction Motor Using Svpwm And Hysteresis Current Controller" Jatit & Lls, Vol. 30 No.1, 1992-8645.
- [11] C. M. Wang, "A novel single-stage full-bridge buck-boost inverter," Applied Power Electronics Conference and Exposition, 2003. APEC '03. Eighteenth Annual IEEE, vol.1, no., pp. 51- 57 vol.1, 9-13 Feb. 2003
- [12] B. B. Ismail, "Design And Development Of Unipolar Spwm Switching Pulses For Single Phase full bridge Inverter application",MS Universality Sains Malaysia, 2008
- [13] M. J. McCarty, "Determining the Optimum Operating Parameters of a Unipolar Pwm Inverter," Thesis of Master of Science Electrical Engineering, California Polytechnic State University, San Luis Obispo May 2010.